

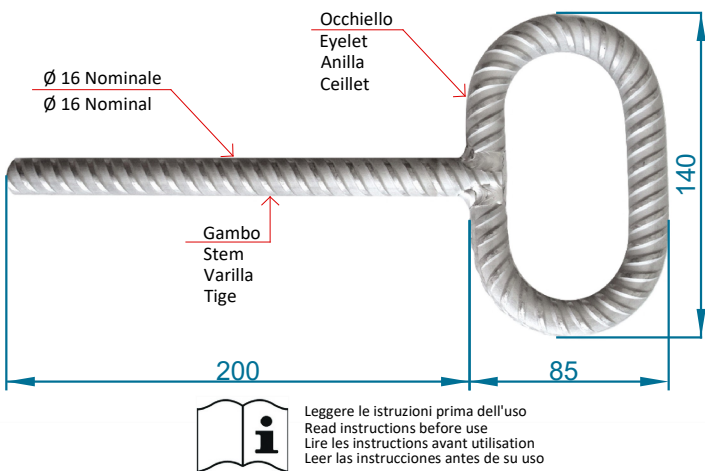

VIA FERRATA

Art. 730* - PEDIGLIA - acciaio inox AISI 304
 Art. 730* - PEDIGLIA - Stainless steel AISI 304
 Art. 730* - PEDIGLIA - inoxidable AISI 304
 Art. 730* - PEDIGLIA - inox AISI 304

COMPLIES WITH EN 16869:2017
Design/construction of Via Ferratas



Dopo la resinatura, non toccare più l'ancoraggio piazzato e utilizzarlo non prima che siano trascorse 24 ore, meglio ancora se non almeno dopo 2/3 giorni (dipende dalla temperatura ambiente...). Rispettare comunque le indicazioni stabilite dalla fabbrica della resina utilizzata.

After the resin, do not touch the anchor and use it no earlier than 24 hours, even better if after 2/3 days (dependent on ambient temperature...). Please, comply with the directions set by the factory of the resin used.

Después de aver colocado el anclaje con la resina, no toque el anclaje y utilizarlo no antes de 24 horas, aún mejor si no menos después de 2/3 días (dependiendo de la temperatura ambiente...). Respetar las instrucciones de la resina utilizada, como escrito en las hoja tecnicas del producto.

Après la résine, ne touchez pas l'ancre et l'utiliser placé au plus tôt 24 heures, encore mieux si pas moins après 2/3 jours (en fonction de la température ambiante...). Toujours se conformer aux orientations fixées par l'usine de la résine utilisée.

ART. 730 *

INSTALLAZIONE CON RESINA
 INSTALACIÓN CON RESINA

INSTALLATION WITH RESIN
 INSTALLATION AVEC RÉSINE

1

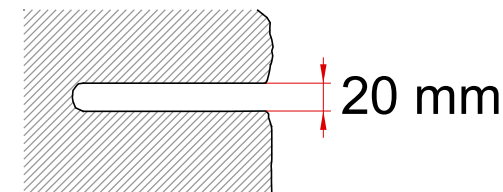
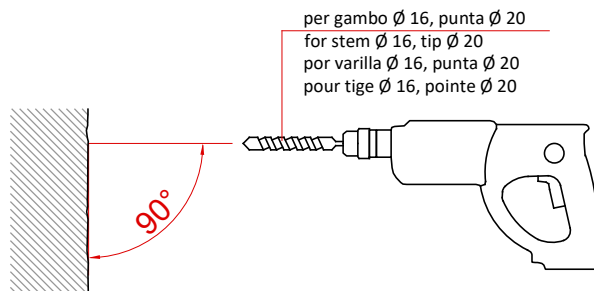

2

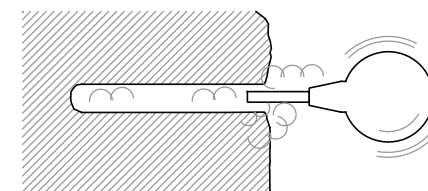
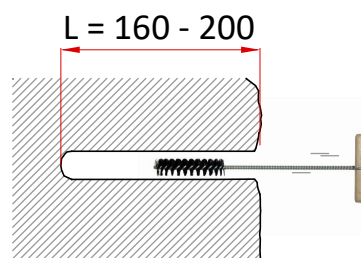
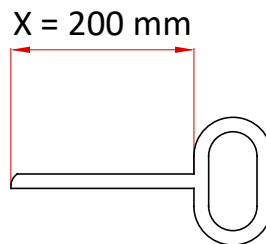

3

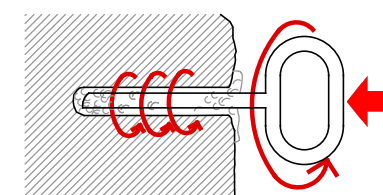
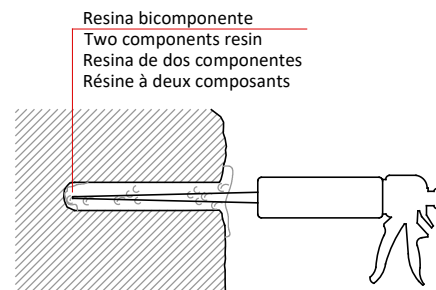
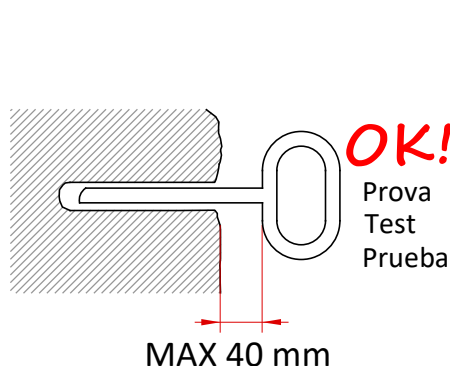

4

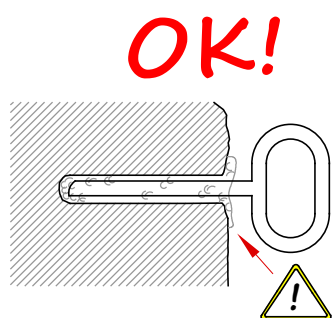

Piazzamento corretto : ORIZZONTALE!!!
 Correct placement: HORIZONTAL!!!

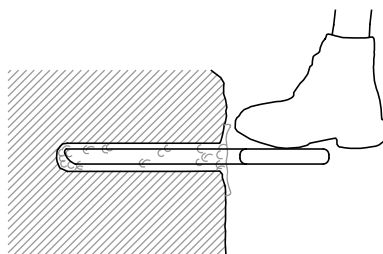

Le placement correct: HORIZONTAL!!!
 La correcta colocación: HORIZONTAL!!!

